

# WATER PRESSURE REGULATORS

	DESCRIPTION	SUPPLY PRESSURE max. bar	PRESSURE RANGE bar	CONNECTION thread	SERIES	PAGE
<b>MINIATURE</b>	made of plastic	11	0 ... 1.0 / 9	G $\frac{1}{8}$ and G $\frac{1}{4}$	R25	<b>9.02</b>
	made of plastic	11	0 ... 1.8 / 9	G $\frac{1}{4}$ and G $\frac{3}{8}$	R45	<b>9.02</b>
	preset, for drinking water	15	1 / 2 / 3... 8	G $\frac{1}{4}$	239K	<b>9.03</b>
<b>STANDARD</b>	female thread	60	0.2 ... 2 / 45	G $\frac{1}{4}$ - G2	RWI	<b>9.04</b>
	male thread	25	0.2 ... 2 / 20	R $\frac{1}{2}$ " - R $2\frac{1}{2}$ "	RWA	<b>9.06</b>
	flange	40	0.2 ... 2 / 20	DN 8-DN125	RWF	<b>9.08</b>
	stainless steel, flange	40	0.2 ... 2 / 20	DN15-DN50	RAF	<b>9.10</b>
	stainless steel, female thread	40	0.2 ... 2 / 20	G $\frac{1}{2}$ - G2	RAI	<b>9.12</b>
<b>STEAM PRESSURE REGULATOR</b>	spheroidal graphite iron	19	0.14 ... 1.7 / 9	G $\frac{1}{2}$ - G2, flange	RU	<b>9.14</b>
	red brass	17	0.14 ... 1.7 / 9	G $\frac{1}{2}$ - G2, flange	RU-R	<b>9.14</b>
	stainless steel	19	0.14 ... 1.7 / 9	G $\frac{1}{2}$ - G2, flange	RU-S	<b>9.14</b>



# 9

Special



9

<b>Description</b>	Miniature pressure regulator with diaphragm, designed for compressed air and water applications. All internal wetted sections are corrosion-resistant, lead free and without any brass components. Regulator for modular application with many integrated fixing holes.		
<b>Media</b>	compressed air, non-corrosive gases or water		
<b>Supply pressure</b>	max. 11 bar		
<b>Adjustment</b>	by plastic knob with snap-lock		
<b>Relieving function</b>	relieving for air, non-relieving for water		
<b>Gauge port</b>	G $\frac{1}{8}$ on both sides of R25,	G $\frac{1}{4}$ on both sides of R45, screw plugs supplied	
<b>Mounting position</b>	any		
<b>Temperature range</b>	0 °C to 50 °C / 32 °F to 122 °F		
<b>Material</b>	Body: glass fibre-reinforced acetal	Elastomer: NBR/Buna-N	
	Inner valve: glass fibre-reinforced acetal		

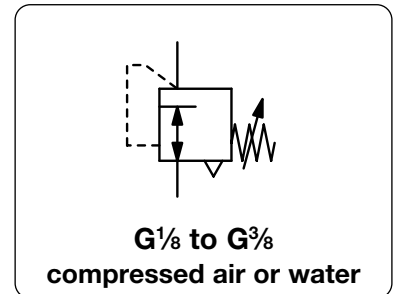

Dimensions			Flow rate		Connection	Pressure	Order no.	Order no. for
A	B	C	water	air	thread	range	for water	compressed air
mm	mm	mm	l/min*1	l/min*1	G	bar	non-relieving	relieving

Pressure regulator							supply pressure max. 11 bar	R25
40	78	12	3	150	G $\frac{1}{8}$	0...1.0	<b>R25-010K</b>	<b>R25-010</b>
						0...1.8	<b>R25-01AK</b>	<b>R25-01A</b>
						0...4.0	<b>R25-01BK</b>	<b>R25-01B</b>
						0...9.0	<b>R25-01CK</b>	<b>R25-01C</b>
40	78	12	3	150	G $\frac{1}{4}$	0...1.0	<b>R25-020K</b>	<b>R25-020</b>
						0...1.8	<b>R25-02AK</b>	<b>R25-02A</b>
						0...4.0	<b>R25-02BK</b>	<b>R25-02B</b>
						0...9.0	<b>R25-02CK</b>	<b>R25-02C</b>



R25

Pressure regulator for high flow							supply pressure max. 11 bar	R45
52	87	14	10	680	G $\frac{1}{4}$	0...1.8	<b>R45-02AK</b>	<b>R45-02A</b>
						0...4.0	<b>R45-02BK</b>	<b>R45-02B</b>
						0...9.0	<b>R45-02CK</b>	<b>R45-02C</b>
52	87	14	13	960	G $\frac{3}{8}$	0...1.8	<b>R45-03AK</b>	<b>R45-03A</b>
						0...4.0	<b>R45-03BK</b>	<b>R45-03B</b>
						0...9.0	<b>R45-03CK</b>	<b>R45-03C</b>



R45

### Special options, add the appropriate letter

<b>adjustment lock</b>	socket wrench adjustment, height 64 mm	R25 only R25-0..T
<b>EPDM-Elastomerc</b>		R.5-0..E

### Accessories, enclosed

<b>pressure gauge</b>	Ø 40 mm, 0...*2 bar, G $\frac{1}{8}$	for R25 <b>MA4001-..*2</b>
	Ø 50 mm, 0...*2 bar, G $\frac{1}{4}$	for R45 <b>MA5002-..*2</b>
<b>mounting bracket</b>	made of steel	<b>BW30-02</b>
<b>mounting nut</b>	made of plastic	<b>R05X51</b>
	made of aluminium	<b>M30x1,5A</b>

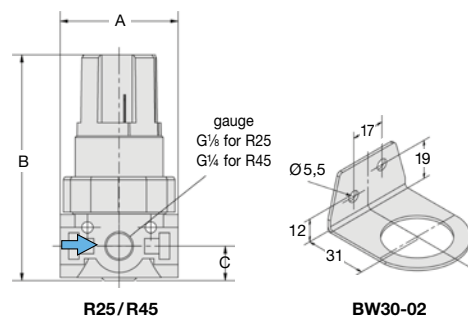
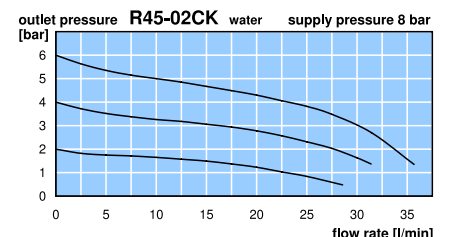
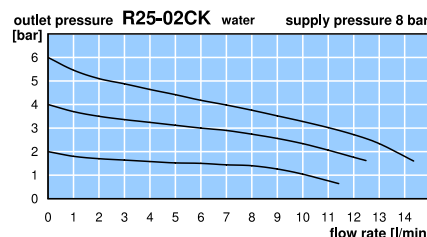
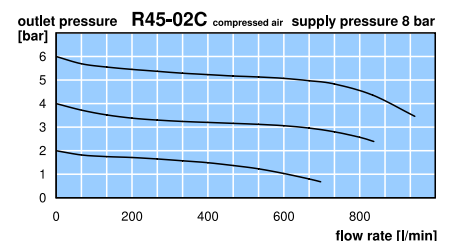
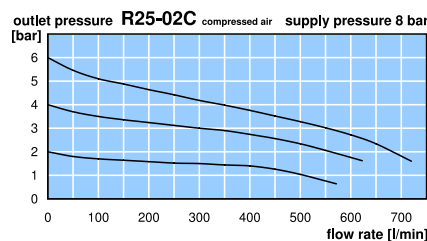

R25/R45

BW30-02

\*1 at 8 bar supply pressure, 6 bar outlet pressure and 1 bar pressure drop, for water supply pressure 2 bar above outlet pressure  
 \*2 01 = 0...1 bar, 02 = 0...2.5 bar, 04 = 0...4 bar, 10 = 0...10 bar

\* Product group

Gauges: see chapter for measuring devices

PDF CAD  
www.aircom.net



Order example:  
R25-010K

<b>General</b>	In-Line pressure regulator with factory-set outlet pressure, reducing from e.g. 10 bar to 5 bar. The outlet pressure cannot be subsequently adjusted. This safeguards against tampering.	
<b>Description</b>	regulator for <b>drinking water</b> certified according to NSF 61, 372	
<b>Application</b>	applications areas such as drinking water, food and medical industry	
<b>Supply pressure</b>	max. 15 bar	
<b>Accuracy</b>	± 0.3 bar, for compressed air P <sub>1</sub> : 6 bar and 10 l/min	
<b>Temperature range</b>	4 °C to 60 °C / 39.2 °F to 140 °F	
<b>Material</b>	Body: Grivory® GV-5 FWA Inner parts: Stainless steel DIN 1.4404 / AISI 316L Diaphragm: EPDM	O-rings: FKM

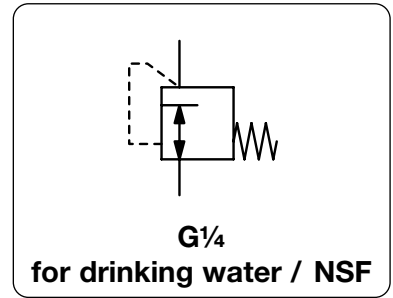

Dimensions			Flow rate	Supply	Connection	Outlet	Order
ØA	B	A/F	water	pressure	thread	pressure	number
mm	mm	mm	l/min*1	max. bar	G	bar*2	

Regulator for drinking water				Grivory, accuracy *2	P <sub>1</sub> : max. 15 bar,	239K
34	52	17	10	15	G <sup>1</sup> / <sub>4</sub>	1 <b>239K0210</b>
			10			2 <b>239K0220</b>
			10			3 <b>239K0230</b>
			10			4 <b>239K0240</b>
			10			5 <b>239K0250</b>
			10			6 <b>239K0260</b>
			10			7 <b>239K0270</b>
			10			8 <b>239K0280</b>



239K

## Special options, add the appropriate letter

<b>NPT</b>	connection thread	239K1 . . .
<b>deviant pressure range</b>	indicate on order	239K . . <b>XX</b>

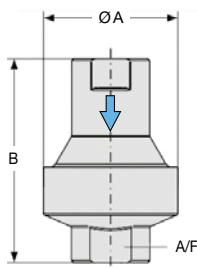

239K

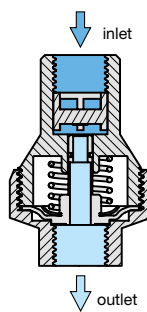

cross-section

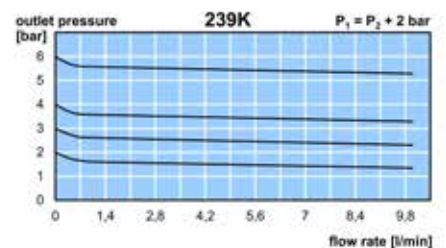

\*1 P<sub>1</sub> = 10 bar; Δp = 0.8 bar

\*2 Tolerance: < 4 bar ± 0.3 bar (air, P<sub>e</sub> = 6 bar, 10 l/min)  
≥ 4 bar ± 10% (air, P<sub>e</sub> = 10 bar, 10 l/min)

\* Product group



# PRESSURE REGULATOR FOR WATER, WITH FEMALE THREAD

RWI

**Description**

Regulator independent of inlet pressure, made of gunmetal, with strainer of stainless steel. Regulators up to 10 bar outlet pressure equipped with diaphragm, all others are piston-operated. particularly all regulators RWI...C with outlet range 1.5 ...6 bar

**Drinking water**

**Media**

preferably water or drinking water, but also compressed air, neutral liquids and non-corrosive gases. Especially suitable for compressed air are regulators RWI...D. It has to be considered that these regulators are non-relieving.

**Pressure difference Reduction ratio**

1 bar, between inlet and outlet pressure  
between supply and outlet pressure should not be greater than:  
20:1 for RWI...A, 10:1 for RWI...D, 6:1 for RWI...G/H, 3:1 for RWI...I

**Mounting position**

any, preferably vertical  
G¼ on both sides of the body for outlet pressure, ports are closed with screw plugs.

**Gauge port**

**ATEX**

**PED**

**Temperature range**

**Material**

according to ATEX2014/34/EU, EN1127, EN13463 for zone 1, 2, 21 and 22 according to EU directives DGRL/PED for liquids and gases of group 2  
0 °C to 80 °C / 32 °F to 176 °F  
see opposite page

**Screw standard**

according to DIN ISO 228

drinking water

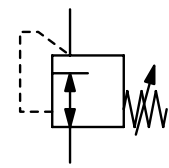

G¼ up to G2  
0.2... 2/45 bar

Dimensions			Flow rate	Kvs	Nominal	Connection	Pressure		Order	B*
A	B	C	recommended	value	size	thread	inlet	outlet	number	
mm	mm	mm	(m³/h)*1	(m³/h)*2	DN	G	max. bar	bar		

**Regulator with female thread**

gunmetal, NBR/Buna-N  
drinking water: RWI...C

**RWI**

70	186	46	0.2	0.5	DN8	G¼	25	0.2 ... 2	RWI-02A
	167	47					25	1.5 ... 8	RWI-02D
	188	47					40	2.0 ... 20	RWI-02H
	191	48					60	20 ... 45	RWI-02I
70	186	46	0.2	0.6	DN10	G¾	25	0.2 ... 2	RWI-03A
	167	47					25	1.5 ... 8	RWI-03D
	188	47					40	2.0 ... 20	RWI-03H
	191	48					60	20 ... 45	RWI-03I
85	154	27	1.3	2.9	DN15	G½	16	0.2 ... 2	RWI-04A
	168	27	1.3	2.9			25	0.5 ... 4	RWI-04B
	168	27	1.3	2.9			25	1.5 ... 6	RWI-04C
	189	47	0.5	1.2			25	1.5 ... 8	RWI-04D
	163	27	1.3	2.9			25	1.5 ... 10	RWI-04E
	182	27	1.3	2.9			25	1.5 ... 12	RWI-04F
	233	27	1.3	2.9			25	2.0 ... 20	RWI-04G
	229	47	0.5	1.2			40	2.0 ... 20	RWI-04H
	218	47	0.5	1.2			60	20 ... 45	RWI-04I
95	157	27	2.3	3.9	DN20	G¾	16	0.2 ... 2	RWI-06A
	169	27	2.3	3.8			25	0.5 ... 4	RWI-06B
	169	27	2.3	3.9			25	1.5 ... 6	RWI-06C
	190	47	0.6	1.3			25	1.5 ... 8	RWI-06D
	164	27	2.3	3.9			25	1.5 ... 10	RWI-06E
	182	27	2.3	3.9			25	1.5 ... 12	RWI-06F
	234	27	2.3	3.9			25	2.0 ... 20	RWI-06G
	229	47	0.6	1.3			40	2.0 ... 20	RWI-06H
	218	47	0.5	1.2			60	20 ... 45	RWI-06I
105	156	29	3.6	5.4	DN25	G1	16	0.2 ... 2	RWI-08A
	105	170	29	3.6			25	0.5 ... 4	RWI-08B
	105	170	29	3.6			25	1.5 ... 6	RWI-08C
	95	242	56	0.7			25	1.5 ... 8	RWI-08D
	105	164	29	3.6			25	1.5 ... 10	RWI-08E
	105	184	29	3.6			25	1.5 ... 12	RWI-08F
	105	235	29	3.6			25	2.0 ... 20	RWI-08G
	95	256	55	0.7			40	2.0 ... 20	RWI-08H



RWI-02...-03A

RWI-04...-10A



RWI-02...-08D

RWI-02...-08H/I



RWI-02...-10B/C/E/F/G

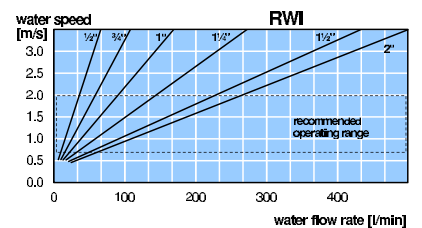
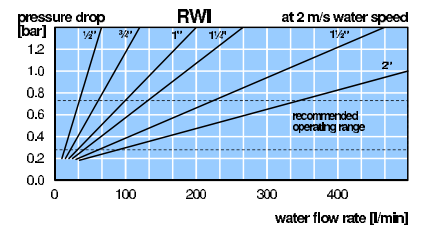

\* Product group

Special

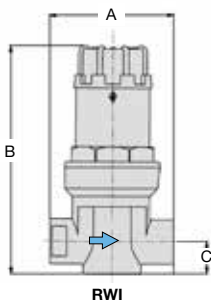

RWI

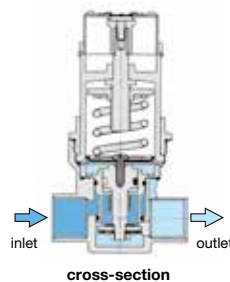

cross-section

\*1 at 2 m/s water speed

\*2 for compressed air the flow is 70 times greater

PDF CAD  
www.aircom.net



Order example:  
RWI-02A

# PRESSURE REGULATOR FOR WATER, WITH FEMALE THREAD

RWI

		Material										
Regulator	RW	RWI...A	RWI...B	RWI...C	RWI...D	RWI...E	RWI...F	RWI...G	RWI...H	RWI...J		
Nominal size	DN	DN8-10	DN15-80	DN15-50	DN15-50	DN8-50	DN15-50	DN15-50	DN15-50	DN8-20		
Body	all	gunmetal CnSn5Zn5Pb2-C-GS / CC499K (Rg5)										
Spring cage	< DN32	Ms (< DN25)	PA	Ms	PA	Ms (< DN25)	Ms	Ms (< DN25)	Ms (< DN25)	Ms (< DN25)		
	> DN40	-	Rg	GG	GG (> DN32)	GG	GG (> DN32)	GG (> DN32)	GG (> DN32)	GG (> DN32)		
Seals	all	NBR/Buna N										
Diaphragm	< DN25	CR	NBR/Buna N	NBR/Buna N	NBR/Buna N	NBR/Buna N	NBR/Buna N	NBR/Buna N	NBR/Buna N	NBR/Buna N		
	> DN32		NBR/Buna N	CR	NBR/Buna N	CR	NBR/Buna N	piston / NBR/Buna N	piston / NBR/Buna N	piston / NBR/Buna N		
Spring cage	< DN32	Ms	Ms, SS, Ho	Ms	Ms	Ms, SS, Ho (< DN25 Ms)	Ms	Ms	Ms	Ms		
	> DN40	-	Ms, SS	Ms, Rg, SS	Ms, Rg, SS	Ms, SS	Ms, SS	Ms, Rg, SS	Ms, Rg, SS	Ms		
Reg. assembly	< DN32	cartridge			valve seat			cartridge			valve seat	
removable	> DN40				valve seat							
Legend:		Ms: brass	SS: stainless steel	Rg: gunmetal	GG: grey cast iron	Ho: Hostaform C						

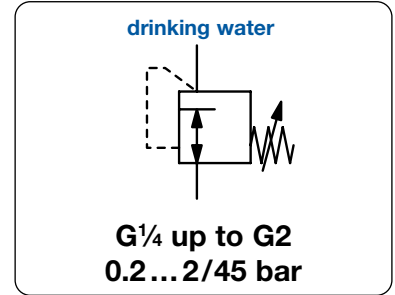

Dimensions			Flow rate	Kvs-	Nominal	Connection	Pressure		Order	
A	B	C	recommended	value	size	thread	inlet	outlet	number	B*
mm	mm	mm	(m <sup>3</sup> /h)*1	(m <sup>3</sup> /h)*2	DN	G	max. bar	bar		

Regulator with female thread						gunmetal, NBR/Buna-N drinking water: RWI...C	RWI		
120	174	47	5.8	6.1	DN32	G1 $\frac{1}{4}$	16	0.2 ... 2	RWI-10A
120	187	47	5.8	6.0			25	0.5 ... 4	RWI-10B
120	186	47	5.8	6.1			25	1.5 ... 6	RWI-10C
104	323	61	3.0	4.2			25	1.5 ... 8	RWI-10D
120	182	47	5.8	6.1			25	1.5 ... 10	RWI-10E
120	200	47	5.8	6.1			25	1.5 ... 12	RWI-10F
120	252	47	5.8	6.1			25	2.0 ... 20	RWI-10G
104	385	61	3.0	4.2			40	1.5 ... 20	RWI-10H
150	371	60	9.0	9.0	DN40	G1 $\frac{1}{2}$	16	0.2 ... 2	RWI-12A
150	301	60	9.0	9.0			25	0.5 ... 4	RWI-12B
150	293	52	9.0	9.0			25	1.5 ... 6	RWI-12C
108	323	61	3.2	4.5			25	1.5 ... 8	RWI-12D
150	365	52	9.0	9.0			25	1.5 ... 10	RWI-12E
150	361	60	9.0	9.0			25	1.5 ... 12	RWI-12F
150	386	60	9.0	9.0			25	2.0 ... 20	RWI-12G
108	392	61	3.2	4.5			40	1.5 ... 20	RWI-12H
160	371	60	14	13	DN50	G2	16	0.2 ... 2	RWI-16A
160	301	60	14	13			25	0.5 ... 4	RWI-16B
160	293	52	14	13			25	1.5 ... 6	RWI-16C
147	378	72	6.9	7.2			25	1.5 ... 8	RWI-16D
160	365	52	14	13			25	1.5 ... 10	RWI-16E
160	361	60	14	13			25	1.5 ... 12	RWI-16F
160	386	60	14	13			25	2.0 ... 20	RWI-16G
147	421	72	6.9	7.2			40	1.5 ... 20	RWI-16H



## Special options, add the appropriate letter

NPT	connection thread	RWI-...N
Elastomer	CR: C FKM: V	RWI-...V
for different media	warm-, hot-, and see water, acids, bases, oil, petrol glue, food, foam, gases etc.	RWI-...X

## Accessories, enclosed

pressure gauge	$\varnothing$ 50 mm, 0... <sup>*3</sup> bar, G $\frac{1}{4}$	up to G $\frac{1}{2}$ MA5002-... <sup>*3</sup>
	$\varnothing$ 63 mm, 0... <sup>*3</sup> bar, G $\frac{1}{4}$	from G $\frac{3}{4}$ MA6302-... <sup>*3</sup>

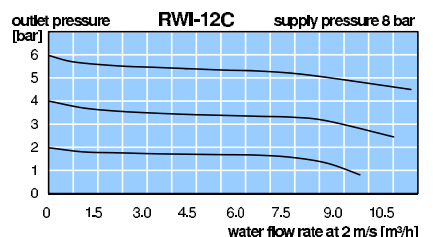
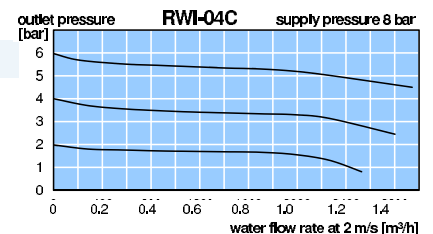
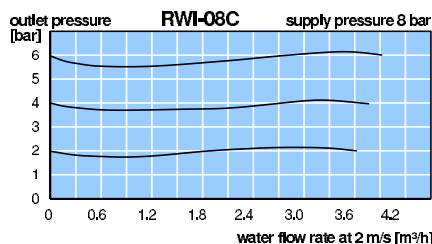
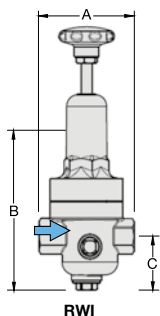

\*1 at 2 m/s water speed \*2 for compressed air the flow is 70 times greater  
\*3 02 = 0...2 bar, 04 = 0...4 bar, 06 = 0...6 bar, 10 = 0...10 bar, 16 = 0...16 bar, 25 = 0...25 bar, 60 = 0...60 bar

Gauges: see chapter for measuring devices

PDF CAD  
www.aircom.net

\* Product group



Order example:  
RWI-10A



Special



# PRESSURE REGULATOR FOR WATER, WITH MALE THREAD

RWA

**Description** Regulator independent of inlet pressure, made of gunmetal, with strainer of stainless steel. Regulators up to 10 bar outlet pressure equipped with diaphragm, all others are piston-operated. particularly all regulators RWA-...C with pressure range 1.5 ...6 bar. Regulators with DN15 up to DN25 have the same constructions dimensions as D06F from Honeywell, according to DVGW up to DN32.

**Drinking water**  

**Media** preferably water or drinking water, but also compressed air, neutral liquids and non-corrosive gases. It has to be considered that these regulators are non-relieving.

**Pressure difference** 1 bar, between inlet and outlet pressure

**Gauge port** G $\frac{1}{4}$  on both sides of the body for outlet pressure, ports are closed with screw plugs.

**Mounting position** any, preferably vertical

**ATEX** according to ATEX2014/34/EU, EN1127, EN13463 for zone 1, 2, 21 and 22

**PED** according to EU directives DGRL/PED for liquids and gases of group 2

**Temperature range** 0 °C to 80 °C / 32 °F to 176 °F

**Material** see opposite page

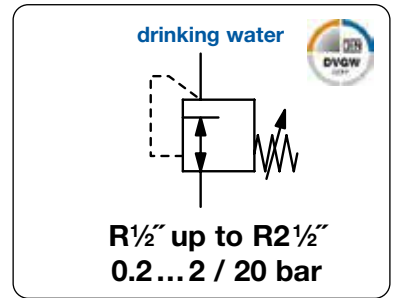

Dimensions			Flow rate	K <sub>vs</sub>	Nominal Connection	Pressure		Order	
A	B	C	recommended	value	size	thread	inlet	outlet	number
mm	mm	mm	(m <sup>3</sup> /h)*1	(m <sup>3</sup> /h)*2	DN	R	max. bar	bar	

Regulator with male thread							gunmetal, NBR/Buna-N drinking water: RWA-...C	RWA		
137	154	27	1,3	2.9	DN15	1/2"	16	0.2 ... 2	2	RWA-04A
	163						25	0.5 ... 4	4	RWA-04B
	168						25	1.5 ... 6	6	RWA-04C
	163						25	1.5 ... 10	10	RWA-04E
	182						25	1.5 ... 12	12	RWA-04F
	233						25	2.0 ... 20	20	RWA-04G
141	156	27	2,3	3.9	DN20	3/4"	16	0.2 ... 2	2	RWA-06A
	163						25	0.5 ... 4	4	RWA-06B
	168						25	1.5 ... 6	6	RWA-06C
	163						25	1.5 ... 10	10	RWA-06E
	182						25	1.5 ... 12	12	RWA-06F
	233						25	2.0 ... 20	20	RWA-06G
161	155	29	3,6	5.4	DN25	1"	16	0.2 ... 2	2	RWA-08A
	164						25	0.5 ... 4	4	RWA-08B
	168						25	1.5 ... 6	6	RWA-08C
	164						25	1.5 ... 10	10	RWA-08E
	182						25	1.5 ... 12	12	RWA-08F
	233						25	2.0 ... 20	20	RWA-08G
177	156	47	5,8	6.1	DN32	1 1/4"	16	0.2 ... 2	2	RWA-10A
	219						25	0.5 ... 4	4	RWA-10B
	222						25	1.5 ... 6	6	RWA-10C
	219						25	1.5 ... 10	10	RWA-10E
	234						25	1.5 ... 12	12	RWA-10F
	252						25	2.0 ... 20	20	RWA-10G

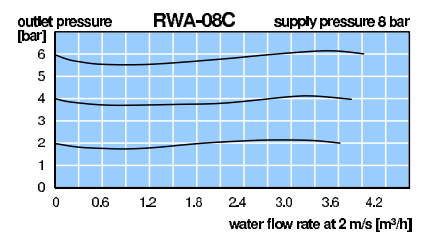
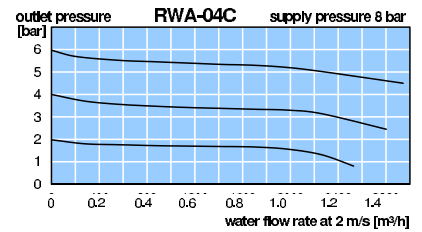
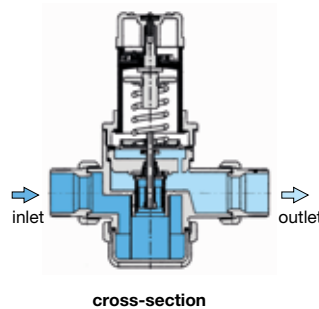
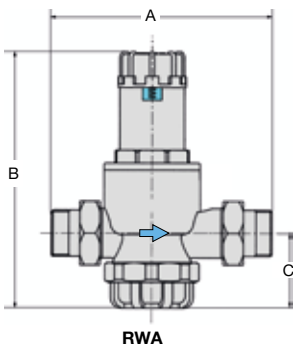

\*1 at 2 m/s water speed      \*2 for compressed air the flow is 70 times greater

\* Product group

PDF CAD  
www.aircom.net

 Order example:  
RWA-04A

# PRESSURE REGULATOR FOR WATER, WITH MALE THREAD

RWA

		Material					
Regulator	RW	RWA-..A	RWA-..B	RWA-..C	RWA-..E	RWA-..F	RWA-..G
Nominal size	DN	DN15-65	DN15-65	DN15-65	DN15-65	DN15-100	DN15-65
Body	all	gunmetal CnSn5Zn5Pb2-C-GS / CC499K (Rg5)					
Spring cage	< DN32	PA	Ms	PA	Ms	Ms (< DN25)	Ms (< DN25)
	> DN40	Rg	GG	GG	GG	GG (> DN32)	GG (> DN32)
Seals	all	NBR/Buna N					
Diaphragm	< DN25	NBR/Buna N			NBR/Buna-N piston / NBR/Buna-N		
	> DN32	NBR/Buna N			NBR/Buna-N piston / NBR/Buna-N		
Inner valve	< DN32	Ms, SS, Ho			Ms, SS, Ho (< DN25 Ms)		
	> DN40	Ms, SS			Ms, SS		
Reg. assembly removable	< DN32	cartridge				valve seat	
	> DN40	valve seat				valve seat	

Legend: **Ms**: brass    **SS**: stainless steel    **Rg**: gunmetal    **GG**: grey cast iron    **Ho**: Hostaform C    **NBR/Buna-N**: nitrile rubber

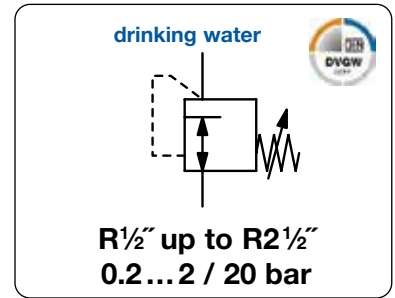

Dimensions			Flow rate	Kvs	Nominal Connection		Pressure		Order number
A	B	C	recommended	value	size	thread	inlet	outlet	
mm	mm	mm	(m <sup>3</sup> /h)*1	(m <sup>3</sup> /h)*2	DN	R	max. bar	bar	B*

Regulator with male thread							gunmetal, NBR/Buna-N drinking water: RWA-..C	RWA	
210	370	59	9,0	9,0	DN40	1½"	16	0.2 ... 2	<b>RWA-12A</b>
	301	51					25	0.5 ... 4	<b>RWA-12B</b>
	293	51					25	1.5 ... 6	<b>RWA-12C</b>
	361	51					25	1.5 ... 10	<b>RWA-12E</b>
	361	51					25	1.5 ... 12	<b>RWA-12F</b>
	386	51					25	2.0 ... 20	<b>RWA-12G</b>
210	372	61	14	13	DN50	2"	16	0.2 ... 2	<b>RWA-16A</b>
	372	61					25	0.5 ... 4	<b>RWA-16B</b>
	294	53					25	1.5 ... 6	<b>RWA-16C</b>
	363	53					25	1.5 ... 10	<b>RWA-16E</b>
	364	53					25	1.5 ... 12	<b>RWA-16F</b>
	388	53					25	2.0 ... 20	<b>RWA-16G</b>
273	394	68	24	20	DN65	2½"	16	0.2 ... 2	<b>RWA-20A</b>
	324						25	0.5 ... 4	<b>RWA-20B</b>
	324						25	1.5 ... 6	<b>RWA-20C</b>
	392						25	1.5 ... 10	<b>RWA-20E</b>
	384						25	1.5 ... 12	<b>RWA-20F</b>
	408						25	2.0 ... 20	<b>RWA-20G</b>



**Special options**, add the appropriate letter

**NPT** connection thread RWA-.. .N  
**Elastomer** CR: C FKM: V RWA-.. .V  
**for different media** warm-, hot-, and see water, acids, bases, oil, petrol glue, food, foam, gases etc. RWA-.. .X

**Accessories**, enclosed

**pressure gauge** Ø 50 mm, 0...<sup>\*3</sup> bar, G¼ G½ **MA5002-..**<sup>\*3</sup>  
 Ø 63 mm, 0...<sup>\*3</sup> bar, G¼ up to G¾ **MA6302-..**<sup>\*3</sup>

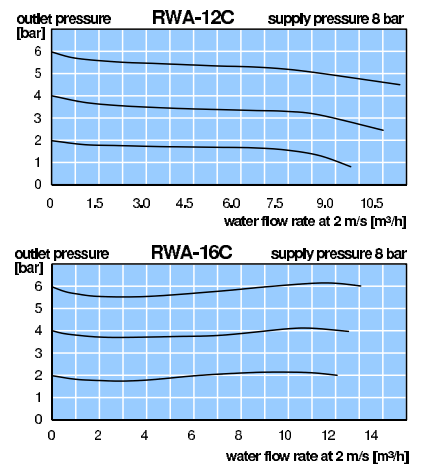
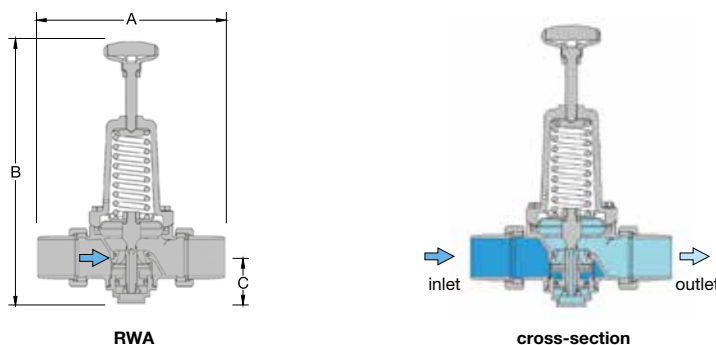

\*1 at 2 m/s water speed    \*2 for compressed air the flow is 70 times greater  
 \*3 02 = 0...2 bar, 04 = 0...4 bar, 06 = 0...6 bar, 10 = 0...10 bar, 16 = 0...16 bar, 25 = 0...25 bar

Gauges: see chapter for measuring devices

PDF CAD  
www.aircom.net

Order example:  
RWA-12A

Special  
9

# PRESSURE REGULATOR FOR WATER, WITH FLANGE

RWF

**Description** Regulator independent of inlet pressure, made of gunmetal, with strainer of stainless steel. Regulators up to 10 bar outlet pressure equipped with diaphragm, all others are piston-operated.

**Drinking water** particularly all regulators RWF-..C with pressure range 1.5 ...6 bar.

**Media** preferably water or drinking water, but also compressed air, neutral liquids and non-corrosive gases. It has to be considered that these regulators are non-relieving.

**Pressure difference** 1 bar, between inlet and outlet pressure

**Gauge port** G $\frac{1}{4}$  on both sides of the body for outlet pressure, ports are closed with screw plugs.

**Mounting position** any, preferably vertical

**ATEX** according to ATEX2014/34/EU, EN1127, EN13463 for zone 1, 2, 21 and 22

**PED** according to EU directives DGRL/PED for liquids and gases of group 2

**Flanges** according to DIN 1092. length according to DIN558-1

**Temperature range** 0 °C to 80 °C / 32 °F to 176 °F

**Material** see opposite page

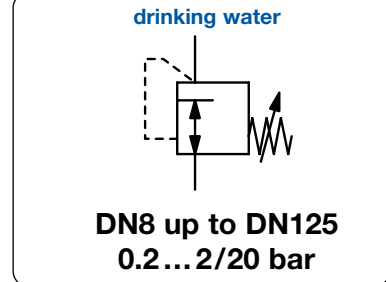

Dimensions				Flow rate	K <sub>vs</sub>	Nominal	Pressure		Order
A	B	C	D	recommended	value	size	inlet	outlet	number
mm	mm	mm	mm	(m <sup>3</sup> /h)*1	(m <sup>3</sup> /h)	DN	max. bar	bar	

Pressure regulator with flange							gunmetal, NBR/Buna N, w/o gauge drinking water: RWF-..C	RWF		
130	178	48	80	0.2	0.5	DN8	25	0.8 ... 8	<b>RWF-02D</b>	
							40	1.5 ... 20	<b>RWF-02G</b>	
				0.2	0.5	DN10	25	0.8 ... 8	<b>RWF-03D</b>	
							40	1.5 ... 20	<b>RWF-03G</b>	
130	175	48	95	1.3	2.9	DN15	16	0.2 ... 2	<b>RWF-04A</b>	
							25	0.5 ... 4	<b>RWF-04B</b>	
								1.5 ... 6	<b>RWF-04C</b>	
								1.5 ... 10	<b>RWF-04E</b>	
								1.5 ... 12	<b>RWF-04F</b>	
								2.0 ... 20	<b>RWF-04G</b>	
150	183	53	105	2.3	3.9	DN20	16	0.2 ... 2	<b>RWF-06A</b>	
							25	0.5 ... 4	<b>RWF-06B</b>	
								1.5 ... 6	<b>RWF-06C</b>	
								1.5 ... 10	<b>RWF-06E</b>	
								1.5 ... 12	<b>RWF-06F</b>	
								2.0 ... 20	<b>RWF-06G</b>	
160	185	58	115	3.6	5.4	DN25	16	0.2 ... 2	<b>RWF-08A</b>	
							25	0.5 ... 4	<b>RWF-08B</b>	
								1.5 ... 6	<b>RWF-08C</b>	
								1.5 ... 10	<b>RWF-08E</b>	
								1.5 ... 12	<b>RWF-08F</b>	
								2.0 ... 20	<b>RWF-08G</b>	
180	197	70	140	5.8	6.1	DN32	16	0.2 ... 2	<b>RWF-10A</b>	
							25	0.5 ... 4	<b>RWF-10B</b>	
								1.5 ... 6	<b>RWF-10C</b>	
								1.5 ... 10	<b>RWF-10E</b>	
								1.5 ... 12	<b>RWF-10F</b>	
								2.0 ... 20	<b>RWF-10G</b>	
200	386	75	150	9.0	9.0	DN40	16	0.2 ... 2	<b>RWF-12A</b>	
							25	0.5 ... 4	<b>RWF-12B</b>	
								1.5 ... 6	<b>RWF-12C</b>	
								1.5 ... 10	<b>RWF-12E</b>	
								1.5 ... 12	<b>RWF-12F</b>	
								2.0 ... 20	<b>RWF-12G</b>	

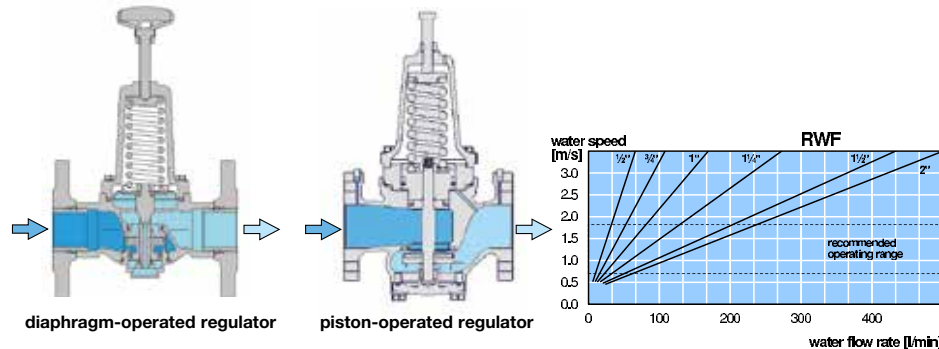
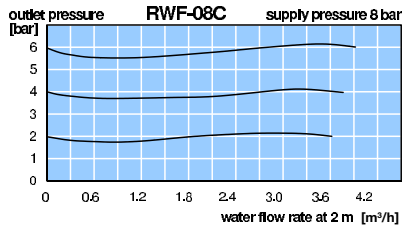
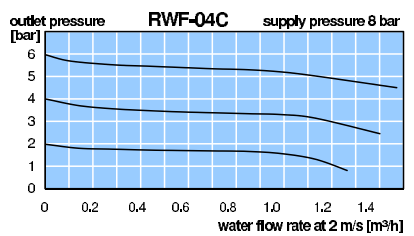
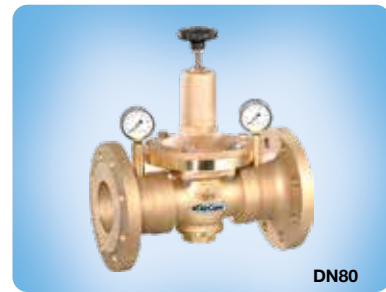

\*1 at 2 m/s water speed      \* for compressed air the flow is 70 times greater

\* Product group

PDF CAD  
www.aircom.net

**Order example:**  
**RWF-02D**



# PRESSURE REGULATOR FOR WATER, WITH FLANGE

RWF

Regulator Nominal size	RW DN	Material						
		RWF-..A		RWF-..B	RWF-..C	RWF-..E	RWF-..F	RWF-..G
		DN8-10	DN15-80	DN15-125	DN15-125	DN15-125	DN15-100	DN8-80
Body	all	gunmetal CnSn5Zn5Pb2-C-GS / CC499K (Rg5)						
Spring cage	< DN32 > DN40	Ms (< DN25) -	PA Rg	Ms	PA	Ms	GG	Ms (< DN25) GG (> DN32)
Seals	all	NBR/Buna-N						
Diaphragm	< DN25 > DN32	CR	NBR/Buna-N				piston / NBR/Buna-N piston / NBR/Buna-N	
Inner valve	< DN32 > DN40	Ms	Ms, SS, Ho			Ms, SS, Ho (< DN25 Ms)		Ms, SS
Reg. assembly removable	< DN32 > DN40	cartridge					valve seat	

Legend: Ms: brass SS: stainless steel Rg: gunmetal GG: grey cast iron Ho: Hostaform C CR: chloroprene rubber, NBR/Buna-N: nitrile rubber

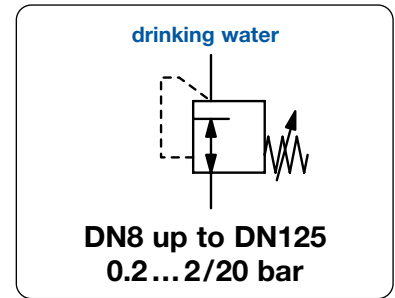

Dimensions			Flow rate	Kvs-	Nominal	Pressure		Order	
A	B	C	D	recommended	value	size	inlet	outlet	number
mm	mm	mm	mm	(m³/h)*1	(m³/h)	DN	max. bar	bar	B*

Pressure regulator with flange							gunmetal, NBR/Buna N, w/o gauge drinking water: RWF-..C	RWF	
230	394	83	165	14	13	DN50	16	0.2 ... 2	RWF-16A
324							25	0.5 ... 4	RWF-16B
324								1.5 ... 6	RWF-16C
396								1.5 ... 10	RWF-16E
384								1.5 ... 12	RWF-16F
411								2.0 ... 20	RWF-16G
290	420	93	185	24	20	DN65	16	0.2 ... 2	RWF-20A
349							25	0.5 ... 4	RWF-20B
349								1.5 ... 6	RWF-20C
418								1.5 ... 10	RWF-20E
411								1.5 ... 12	RWF-20F
429								2.0 ... 20	RWF-20G
310	427	100	200	26	24	DN80	16	0.2 ... 2	RWF-24A
	518	136		60	60			0.5 ... 4	RWF-24B
	356	100		26	24			1.5 ... 6	RWF-24C
	518	136		60	60			1.5 ... 6	RWF-25C
	521			60	60			3.0 ... 10	RWF-24E
	545			60	60		25	4.0 ... 12	RWF-24F
	436			24	24		25	2.0 ... 20	RWF-24G
350	540	140	200	80	80	DN100	16	0.5 ... 4	RWF-32B
	540							1.5 ... 6	RWF-32C
	542							3.0 ... 10	RWF-32E
	600	135						4.0 ... 12	RWF-32F
400	730	165	270	130	130	DN125	16	0.5 ... 4	RWF-40B
	540							1.5 ... 6	RWF-40C
	542							3.0 ... 10	RWF-40E



**Special options, add the appropriate letter**

Elastomer	EPDM: E	CR: C	FKM: V	RWF-.. .V
flange connection	ANSI			RWF-.. .F2
for different media	warm-, hot-, and see water, acids, bases, oil, petrol glue, food, foam, gases etc.			RWF-.. .X

**Accessories, enclosed**

pressure gauge Ø 63 mm, vertical 0...\*2 bar, G1/4 MT6302-..\*2

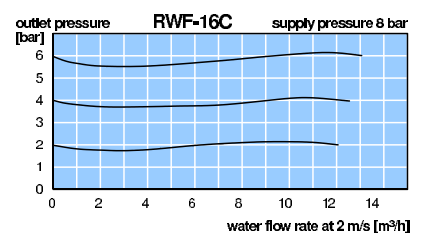
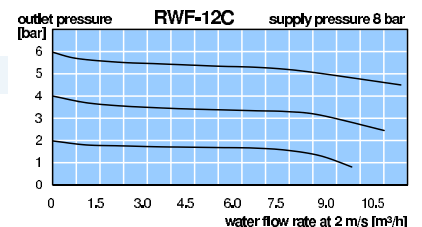
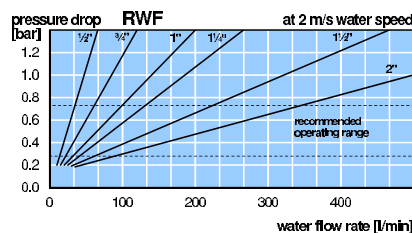
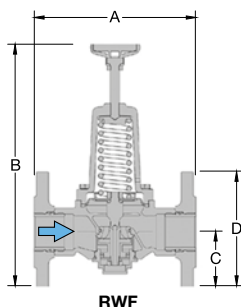

\*1 at 2 m/s water speed \* for compressed air the flow is 70 times greater  
\*2 02 = 0...2 bar, 04 = 0...4 bar, 06 = 0...6 bar, 10 = 0...10 bar, 16 = 0...16 bar, 25 = 0...25 bar

Gauges: see chapter for measuring devices

PDF CAD  
www.aircom.net



Order example:  
RWF-16A

Special  
9

**Description** Pressure regulator made of stainless steel throughout. Even when spindle is unscrewed the indicated minimum outlet pressure is existent. Inner parts are replaceable.  
 With stainless-steel dirt-trap / strainer

**Medium** aggressive liquids, compressed air or non-corrosive gases. Not suitable for steam!

**Supply pressure** see chart, max. 40 bar

**Minimum press. difference**  $P_1 : P_2 = 1$  bar

**Adjustment** with hexagon socket, with locknut

**Relieving function** non-relieving

**Gauge port** G $\frac{1}{4}$  on both sides of the body, one screw plug supplied

**Mounting position** any, preferably vertical

**Flange** according DIN 1092, overall length according DIN 558-1

**Temperature range** 0 °C to 190 °C / 32 °F to 374 °F for FKM for media and ambient temperature  
 0 °C to 130 °C / 32 °F to 266 °F for EPDM for media and ambient temperature

**Material** Body, spring cage, inner valve: stainless steel 1.4408 / V4A / 316 L  
 Elastomer and seals: FKM / FPM, optionally EPDM

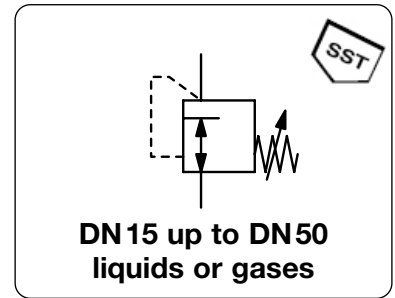

Dimensions			K <sub>v</sub> -value	Flow rate water	Supply pressure max. bar	Mounting flange DN	Pressure range bar	Order number
A	B	C						
mm	mm	mm	(m <sup>3</sup> /h)*1	l/min*2				

Regulator with flange					for liquids, supply pressure max. 25/40 bar non-relieving, 1.4408 / V4A / 316L, FKM		RAF	
130	137	95	2.9	50	25	DN15	0.2 ... 2	RAF-04A
	118				25		0.5 ... 4	RAF-04B
	118				25		1.5 ... 6	RAF-04C
	118				25		1.5 ... 10	RAF-04D
	136				40		2.0 ... 20	RAF-04F
150	137	105	3.9	65	25	DN20	0.2 ... 2	RAF-06A
	118				25		0.5 ... 4	RAF-06B
	118				25		1.5 ... 6	RAF-06C
	118				25		1.5 ... 10	RAF-06D
	137				40		2.0 ... 20	RAF-06F
160	150	115	5.4	90	25	DN25	0.2 ... 2	RAF-08A
	118				25		0.5 ... 4	RAF-08B
	118				25		1.5 ... 6	RAF-08C
	118				25		1.5 ... 10	RAF-08D
	137				40		2.0 ... 20	RAF-08F
180	150	140	6.1	102	25	DN32	0.2 ... 2	RAF-10A
	118				25		0.5 ... 4	RAF-10B
	118				25		1.5 ... 6	RAF-10C
	118				25		1.5 ... 10	RAF-10D
	137				40		2.0 ... 20	RAF-10F

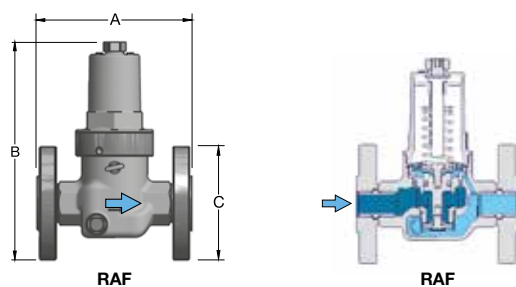
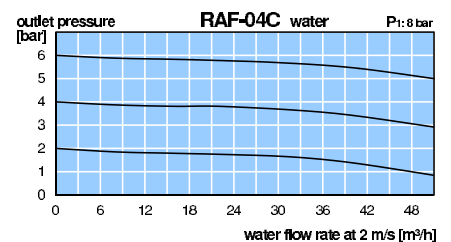
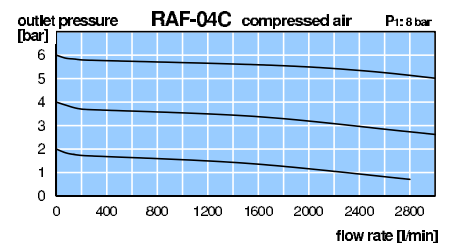

\*1 at 2 m/s water speed      \*2 for compressed air the flow is 70 times greater  
 \*3 02 = 0...2 bar, 04 = 0...4 bar, 06 = 0...6 bar, 10 = 0...10 bar, 16 = 0...16 bar, 25 = 0...25 bar

Gauges: see chapter for measuring devices

PDF CAD  
 www.aircom.net

\* Product group  
 Order example:  
**RAF-04A**

# FLANGE PRESSURE REGULATOR MADE OF STAINLESS STEEL THROUGHOUT

RAF

**Description** Pressure regulator made of stainless steel throughout. Even when spindle is unscrewed the indicated minimum outlet pressure is existent. Inner parts are replaceable.  
 With stainless-steel dirt-trap / strainer  
**Medium** aggressive liquids, compressed air or non-corrosive gases. Not suitable for steam!  
**Supply pressure** see chart, max. 40 bar  
**Minimum press. difference** P<sub>1</sub> : P<sub>2</sub> = 1 bar  
**Adjustment** with hexagon socket, with locknut  
**Relieving function** non-relieving  
**Gauge port** G<sub>1/4</sub> on both sides of the body, one screw plug supplied  
**Mounting position** any, preferably vertical  
**Flange** according DIN 1092, overall length according DIN 558-1  
**Temperature range** 0 °C to 190 °C / 32 °F to 374 °F for FKM for media and ambient temperature  
 0 °C to 130 °C / 32 °F to 266 °F for EPDM for media and ambient temperature  
**Material** Body, spring cage, inner valve: stainless steel 1.4408 / V4A / 316 L  
 Elastomer and seals: FKM / FPM, optionally EPDM

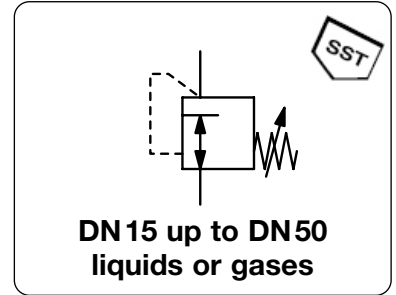

Dimensions			K <sub>v</sub> -value (m <sup>3</sup> /h)*1	Flow rate water l/min*2	Supply pressure max. bar	Mounting flange DN	Pressure range bar	Order number
A	B	C						

Regulator with flange			for liquids, supply pressure max. 25/40 bar non-relieving, 1.4408 / V4A / 316L, FKM				RAF		
200	269	150	9.0	150	25	DN40	0.2 ... 2	RAF-12A	
	219							0.5 ... 4	RAF-12B
	219							1.5 ... 6	RAF-12C
	219							1.5 ... 10	RAF-12D
	247							2.0 ... 20	RAF-12F
230	269	165	13	216	25	DN50	0.2 ... 2	RAF-16A	
	219							0.5 ... 4	RAF-16B
	219							1.5 ... 6	RAF-16C
	219							1.5 ... 10	RAF-16D
	247							2.0 ... 20	RAF-16F



## Special options, add the appropriate letter

EPDM Elastomer membrane and seals, FDA approval RAF-...TD



## Accessories, enclosed

SST pressure gauge Ø 50 mm, 0...<sup>\*3</sup> bar, G<sub>1/4</sub>, for DN 15 MS5002-...<sup>\*3</sup>  
 Ø 63 mm, 0...<sup>\*3</sup> bar, G<sub>1/4</sub>, and all the rest of them MS6302-...<sup>\*3</sup>

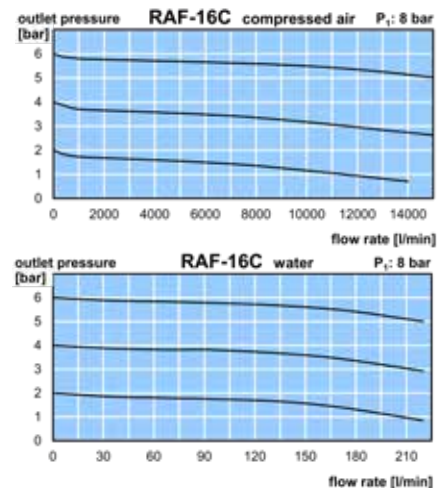
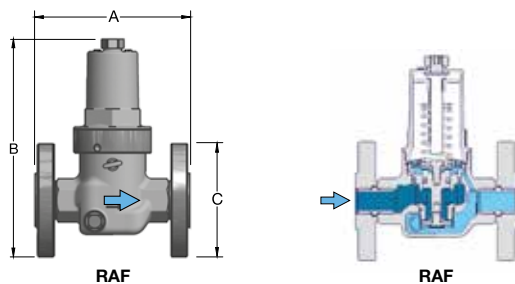

\*1 at 2 m/s water speed \*2 for compressed air the flow is 70 times greater  
<sup>\*3</sup> 02 = 0...2 bar, 04 = 0...4 bar, 06 = 0...6 bar, 10 = 0...10 bar, 16 = 0...16 bar, 25 = 0...25 bar

\* Product group

PDF CAD  
www.aircom.net



Order example:  
RAF-12A

Special



# PRESSURE REGULATOR MADE OF STAINLESS STEEL THROUGHOUT

RAI

<b>Description</b>	Pressure regulator made of stainless steel throughout. Even when spindle is unscrewed the indicated minimum outlet pressure is existent. Inner parts are replaceable. With stainless-steel dirt-trap / strainer
<b>Medium</b>	aggressive liquids, compressed air or non-corrosive gases. Not suitable for steam!
<b>Supply pressure</b>	see chart, max. 40 bar
<b>Minimum press. difference</b>	$P_1 : P_2 = 1$ bar
<b>Adjustment</b>	with hexagon socket, with locknut
<b>Relieving function</b>	non-relieving
<b>Gauge port</b>	G $\frac{1}{4}$ on both sides of the body, one screw plug supplied
<b>Mounting position</b>	any, preferably vertical
<b>Temperature range</b>	0 °C to 190 °C / 32 °F to 374 °F medium and ambient temperature
<b>Material</b>	Body, spring cage, inner valve: stainless steel 1.4408 / V4A / 316L Elastomer and seals: FKM/FPM

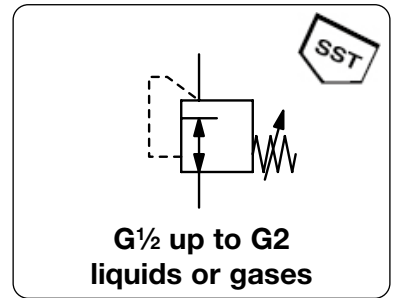

Dimensions			Kv-	Flow rate	Supply	Nominal	Connection	Pressure-	Order	
A	B	C	value	water	pressure	size	thread	range	number	
mm	mm	mm	(m <sup>3</sup> /h)*1	l/min	max. bar	DN	G	bar		

Regulator with female thread				for liquids, supply pressure max. 25/40 bar non-relieving, 1.4408 / V4A / 316L, FKM				RAI	
95	166	29	2,9	50	25	DN15	G $\frac{1}{2}$	0.2 ... 2	RAI-04A
95	147	29			25			0.5 ... 4	RAI-04B
95	147	29			25			1.5 ... 6	RAI-04C
95	147	29			25			1.5 ... 10	RAI-04D
95	165	29			40			2.0 ... 20	RAI-04F
95	166	29	3,9	65	25	DN20	G $\frac{3}{4}$	0.2 ... 2	RAI-06A
95	147	29			25			0.5 ... 4	RAI-06B
95	147	29			25			1.5 ... 6	RAI-06C
95	147	29			25			1.5 ... 10	RAI-06D
95	165	29			40			2.0 ... 20	RAI-06F
110	189	39	5,4	90	25	DN25	G1	0.2 ... 2	RAI-08A
110	157	39			25			0.5 ... 4	RAI-08B
110	157	39			25			1.5 ... 6	RAI-08C
110	157	39			25			1.5 ... 10	RAI-08D
110	176	39			40			2.0 ... 20	RAI-08F
120	189	39	6,1	102	25	DN32	G1 $\frac{1}{4}$	0.2 ... 2	RAI-10A
120	157	39			25			0.5 ... 4	RAI-10B
120	157	39			25			1.5 ... 6	RAI-10C
120	157	39			25			1.5 ... 10	RAI-10D
120	176	39			40			2.0 ... 20	RAI-10F



RAI-04...-10A



RAI-04...10B/C/D



RAI-04...-10D

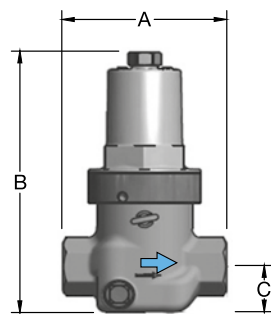

RAI

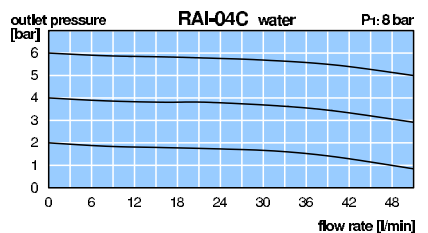
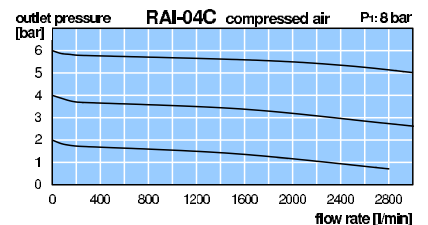

\*1 at 8 bar supply pressure, 6 bar outlet pressure and 1 bar pressure drop

\*2 for compressed air the flow is 65 times greater

\* Product group

PDF CAD  
www.aircom.net



Order example:  
RAI-04A

# PRESSURE REGULATOR MADE OF STAINLESS STEEL THROUGHOUT

RAI

<b>Description</b>	Pressure regulator made of stainless steel throughout. Even when spindle is unscrewed the indicated minimum outlet pressure is existent. Inner parts are replaceable. With stainless-steel dirt-trap / strainer		
<b>Medium</b>	aggressive liquids, compressed air or non-corrosive gases. Not suitable for steam!		
<b>Supply pressure</b>	see chart, max. 40 bar		
<b>Minimum press. difference</b>	$P_1 : P_2 = 1$ bar		
<b>Adjustment</b>	with hexagon socket, with locknut		
<b>Relieving function</b>	non-relieving		
<b>Gauge port</b>	G $\frac{1}{4}$ on both sides of the body, one screw plug supplied		
<b>Mounting position</b>	any, preferably vertical		
<b>Temperature range</b>	0 °C to 190 °C / 32 °F to 374 °F medium and ambient temperature		
<b>Material</b>	Body, spring cage, inner valve:	stainless steel 1.4408 / V4A / 316 L	
	Elastomer and seals:	FKM/FPM	

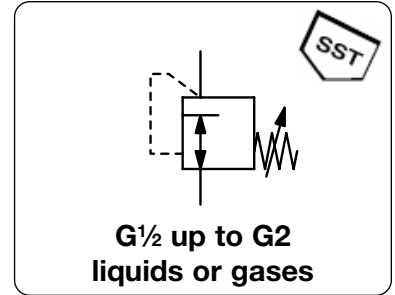

Dimensions			K <sub>v</sub> -value	Flow rate water	Supply pressure	Nominal size	Connection thread	Pressure-range	Order number	
A	B	C	(m <sup>3</sup> /h)*1	l/min	max. bar	DN	G	bar		
mm	mm	mm								

Regulator with female thread										for liquids, supply pressure max. 25/40 bar non-relieving, 1.4408 / V4A / 316L, FKM	RAI
150	306	37	9,0	150	25	DN40	G1 $\frac{1}{2}$	0.2 ... 2	RAI-12A		
150	256	37			25			0.5 ... 4	RAI-12B		
150	256	37			25			1.5 ... 6	RAI-12C		
150	256	37			25			1.5 ... 10	RAI-12D		
150	284	37			40			2.0 ... 20	RAI-12F		
160	306	37	13	216	25	DN50	G2	0.2 ... 2	RAI-16A		
160	256	37			25			0.5 ... 4	RAI-16B		
160	256	37			25			1.5 ... 6	RAI-16C		
160	256	37			25			1.5 ... 10	RAI-16D		
160	284	37			40			2.0 ... 20	RAI-16F		



**Special options,** add the appropriate letter

**EPDM Elastomer** membrane and seals, FDA approval **RAF-. . .TD**



**Accessories,** enclosed

**SST pressure gauge** Ø 50 mm, 0...\*3 bar, G $\frac{1}{4}$ , for DN 15 **MS5002-...\*3**  
 Ø 63 mm, 0...\*3 bar, G $\frac{1}{4}$ , and all the rest of them **MS6302-...\*3**

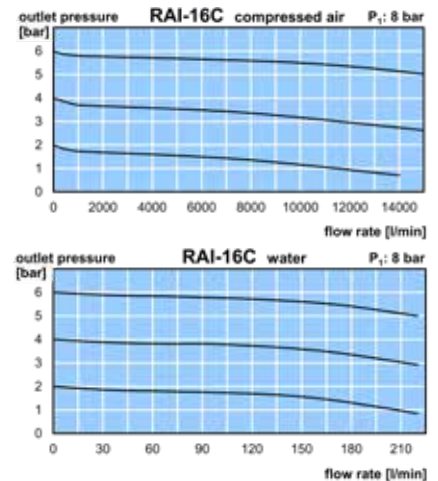

\*1 at 8 bar supply pressure, 6 bar outlet pressure and 1 bar pressure drop      \*2 for compressed air the flow is 65 times greater

\* Product group **Order example: RAI-12A**

PDF CAD  
www.aircom.net

Special  
9

# PRESSURE REGULATOR FOR STEAM UP TO 210 °C / 410 °F

RU

<b>Description</b>	Directly acting pressure regulator with stainless steel inner parts suitable for steam and compressed air.	
<b>Media</b>	compressed air, non-corrosive gases or steam with dryness of at least 98%	
<b>Supply pressure</b>	RUG: max. 19 bar at 210 °C / 410 °F, max. 17 bar for red brass version RUH: max. 10 bar at 184 °C / 363 °F	
<b>Air consumption</b>	without constant bleed	
<b>Adjustment</b>	by plastic knob	<b>Relieving function</b> non-relieving
<b>Gauge port</b>	not available	<b>Mounting position</b> any
<b>Temperature range</b>	RUG: max. 210 °C / 410 °F,	RUH: max. 184 °C / 363 °F
<b>Material</b>	Body: spheroidal cast iron EN-GJS-400-18-LT (GGG40.3), optionally red brass Rg5 or stainless steel 1.4404 at RUG Spring cage: epoxy-coated aluminium, nickel-plated aluminium at RUG Inner valve / bellows: stainless steel 1.4404 and 1.4571 O-ring / seal: EPDM and PTFE	

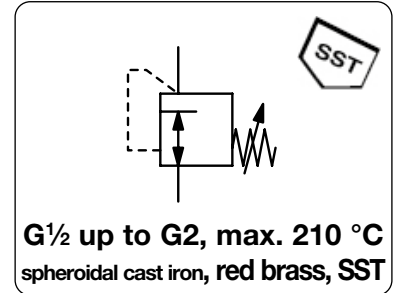

Dimensions			Nominal size	K <sub>v</sub> -value	P <sub>1</sub> max.	Connection thread	Pressure range	Order number
A	B	C	DN	(m <sup>3</sup> /h)	bar	G	bar	
mm	mm	mm						

Pressure regulator for steam								supply pressure max. 10 / 19 bar, non-relieving, spheroidal cast iron	RU
83	190	60	15	1.5	19	G <sup>1/2</sup>	0.14...1.7 1.4 ...4.0 3.5 ...8.6		RUG-04A RUG-04B RUG-04C
96	190	60	20	2.5	19	G <sup>3/4</sup>	0.14...1.7 1.4 ...4.0 3.5 ...8.6		RUG-06A RUG-06B RUG-06C
108	190	60	25	3.0	19	G <sup>1</sup>	0.14...1.7 1.4 ...4.0 3.5 ...8.6		RUG-08A RUG-08B RUG-08C
134	220	67	25	6.8	10	G <sup>1</sup>	0.14...1.7 1.4 ...4.0 3.5 ...9.0		RUH-08A RUH-08B RUH-08C
134	220	67	40	11.5	10	G <sup>1 1/2</sup>	0.14...1.7 1.4 ...4.0 3.5 ...9.0		RUH-12A RUH-12B RUH-12C
134	220	67	50	15.0	10	G <sup>2</sup>	0.14...1.7 1.4 ...4.0 3.5 ...9.0		RUH-16A RUH-16B RUH-16C



RUG-04A



RUG-04BSF  
made of stainless steel, with flange

## Special options, add the appropriate letter

stainless steel 1.4404	body with connection thread	for RUG	RUG-0...S
	body with flange	for RUG	RUG-0...SF
red brass Rg5	body of red brass Rg5, P <sub>1</sub> max. 17 bar	for RUG	RUG-0...R
flange of spheroidal cast iron	GGG40.3	for RUG	RUG-0...F

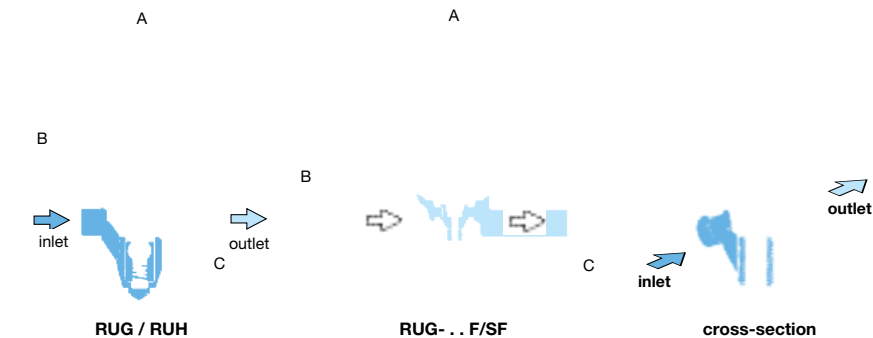
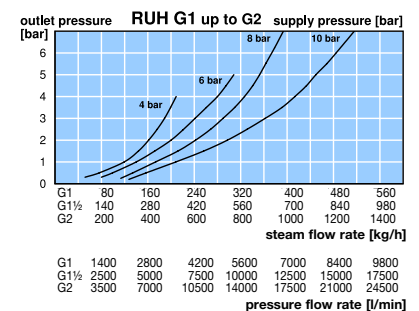
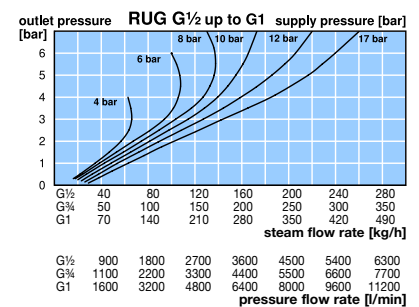

Model	A	B	C
RUG-04R/S	83	192	62
RUG-06R/S	96	192	62
RUG-08R/S	108	192	62

Model	A	B	C
RUG-04F/SF	150	182/192	55/62
RUG-06F/SF	150	192/192	55/62
RUG-08F/SF	160	192/192	55/62

\* Product group

PDF CAD  
www.aircom.net



Order example:  
RUG-04A